

## RidgeMaster®

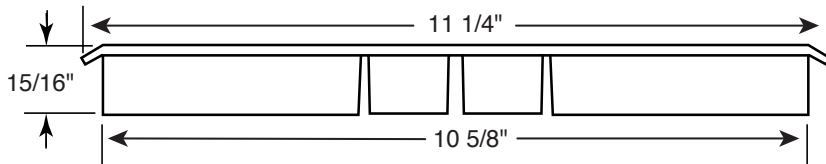

### RidgeMaster®

For roof pitches from 3/12 to 12/12.

Packaged: 40 lineal ft./box (ten 4' pieces)—18 boxes/skid.

Features: Patented internal baffle engineered to keep blowing snow and rain from entering. Also used for fascia vents.

Shipped: Metamora, MI

Item # **00 07 0000 002**

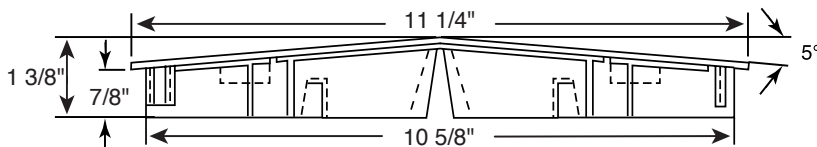

### 11" RidgeMaster® Plus

For roof pitches from 3/12 to 12/12.

Packaged: 40 lineal ft./box (ten 4' pieces)—21 boxes/skid.

Features: Patented added pitch shows more shingle profile and less vent opening. Easily adapts to a Peak Vent or Flash Vent. Patented internal baffle engineered to keep blowing snow and rain from entering.

Shipped: Metamora, MI

Item # **00 07 1100 002**

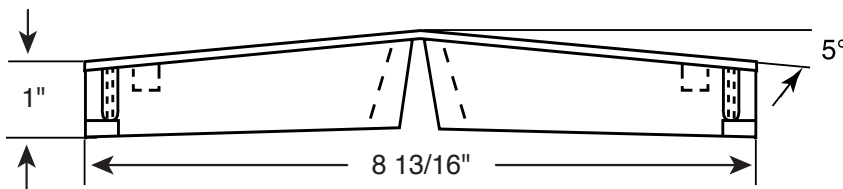

### 9" RidgeMaster® Plus

For 9" ridge.

Packaged: 40 lineal ft./box (ten 4' pieces)—18 boxes/skid.

Features: Patented added pitch shows more shingle profile and less vent opening. Easily adapts to a Peak Vent or Flash Vent. Patented internal baffle engineered to keep blowing snow and rain from entering.

Shipped: Metamora, MI

Item # **00 07 0900 002**

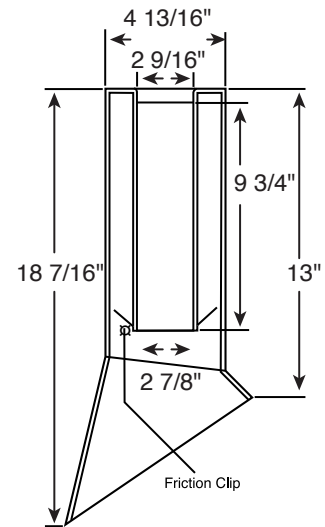

### CapMaster®

Colors: Dark Grey (018), Light Grey (017), Black (002), Brown (010)

Use for: All 3" & 4" vent pipes. Adapts to all roof pitches from 3/12 to 12/12.

Packaged: One/box.

Shipped: Metamora, MI

Item # **00 07 0007 \*\*\***

## HipMaster®

HipMaster photos on page 22.

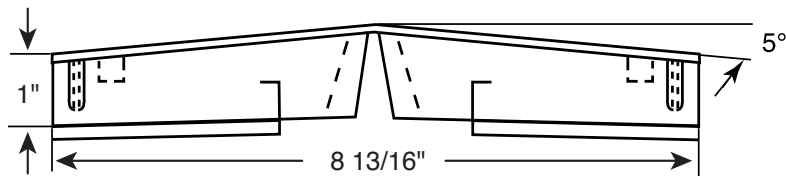

### 9" HipMaster®

For 9" hip and ridge.

**Features:** Patented triple baffle system engineered to keep blowing rain and snow from entering. Can be joined with RidgeMaster Plus.

**Packaged:** 40 lineal ft./box (ten 4' pieces)—18 boxes/skid.

**Shipped:** Metamora, MI

**Item #** 00 07 0911 002

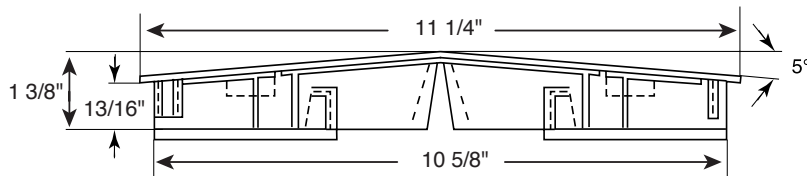

### 11" HipMaster®

For roof pitches from 3/12 to 12/12.

**Packaged:** 40 lineal ft./box (ten 4' pieces)—18 boxes/skid.

**Features:** Patented triple baffle system engineered to keep blowing rain and snow from entering. Can be joined with RidgeMaster Plus.

**Shipped:** Metamora, MI

**Item #** 00 07 1111 002

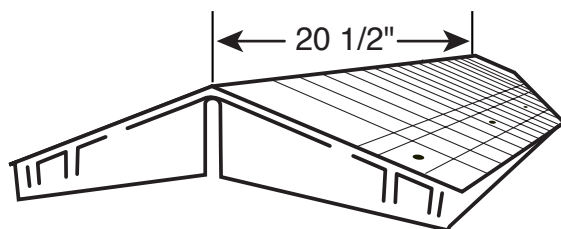

### HipMaster® Starter Piece

Blends HipMaster into roof line at bottom or top of hip.

**Use for:** Regular or 9" HipMaster.

**Packaged:** 4/box.

**Shipped:** Metamora, MI

**Item #** 00 07 0004 002

## How to figure proper ventilation

### Industry Standard for Proper Ventilation:

1 sq. ft. of ventilation for every 300 sq. ft. of attic space with 50% in ridge and 50% in soffit.

### RidgeMaster, RidgeMaster Plus

& HipMaster: 12.228 sq. in. per lineal foot—  
Net Free Ventilation

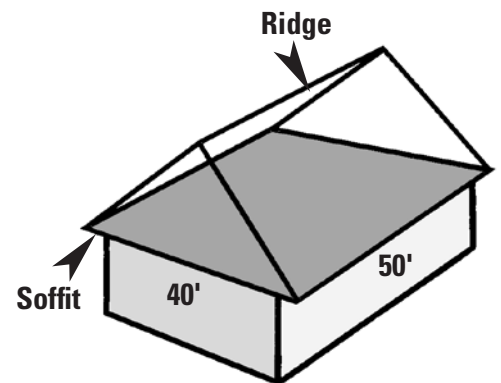

### Example: 2,000 sq. ft. attic

- 40' x 50' = 2,000 sq. ft. attic.
- 2000 sq. ft./300 sq. ft. = 6.67 sq. ft. (total ventilation req.)
- 6.67 x 144 = 960 sq. in. (conversion to inches)
- 960 sq. in. = 480 sq. in. (ridge) + 480 sq. in. (soffit)

A 50' ridge with RidgeMaster installed equals approximately 600 sq. in. of ventilation. (more than industry standards)